

Tommy Screws· DIN 6306 with moveable pin

24500.0017



Product Description

With this version, the pin is moveable and held by the spring.

Material

- Free cutting steel, blackened, pressure lug hardened.

More information

References

Thrust point for thrust pad DIN 6311 form S, EH 22560.

Further products

- Thrust Pads, DIN 6311 and low model

Drawing

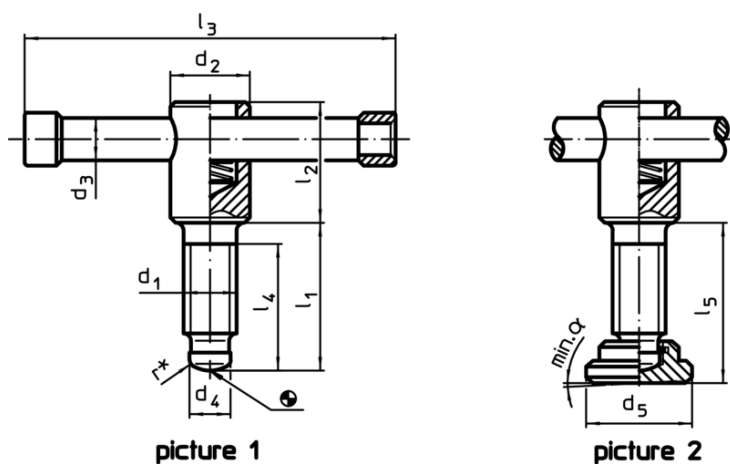

* to ease assembly the DIN 6306 specification has been completed by r

Order information

Dimensions								[g]	Art. No.
d ₁	l ₁	d ₂	d ₃	d ₄	l ₂	l ₃	l ₄		
without thrust pad, form D – picture 1									
M16	70	24	13	12	40	120	60	318	24500.0017