

Tommy Screws· DIN 6304 with fixed pin

24490.0107



Product Description

With this version, the pin is pressed in.

Material

- Free cutting steel, blackened, pressure lug hardened.

More information

References

Thrust point for thrust pad DIN 6311 form S, EH 22560.

Further products

- Thrust Pads, DIN 6311 and low model

Drawing

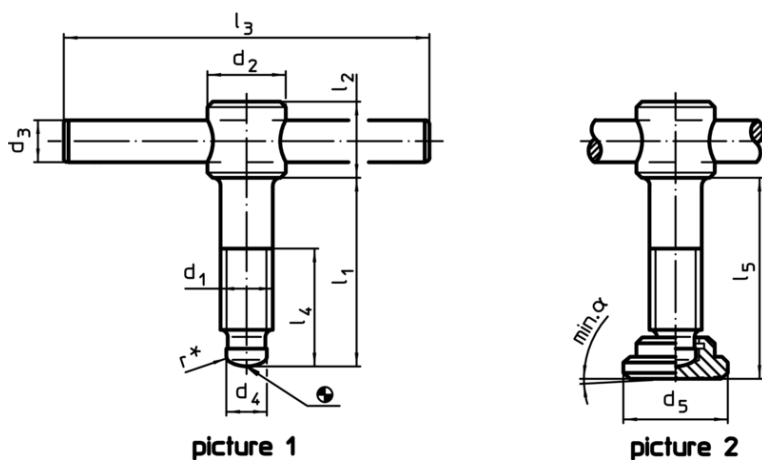

* to ease assembly the DIN 6304 specification has been completed by r

Order information

Dimensions										α min.		Art. No.
d ₁	l ₁	d ₂	d ₃	d ₄	d ₅	l ₂	l ₃	l ₄	l ₅		[g]	
[mm]												
with thrust pad, form F – picture 2												
M6	50	12	5	4,5	12	10	50	40	52,1	7°	28	24490.0107