

## Tommy Screws· DIN 6304 with fixed pin

24490.0011



### Product Description

With this version, the pin is pressed in.

### Material

- Free cutting steel, blackened, pressure lug hardened.

### More information

### References

Thrust point for thrust pad DIN 6311 form S, EH 22560.

### Further products

- Thrust Pads, DIN 6311 and low model

### Drawing

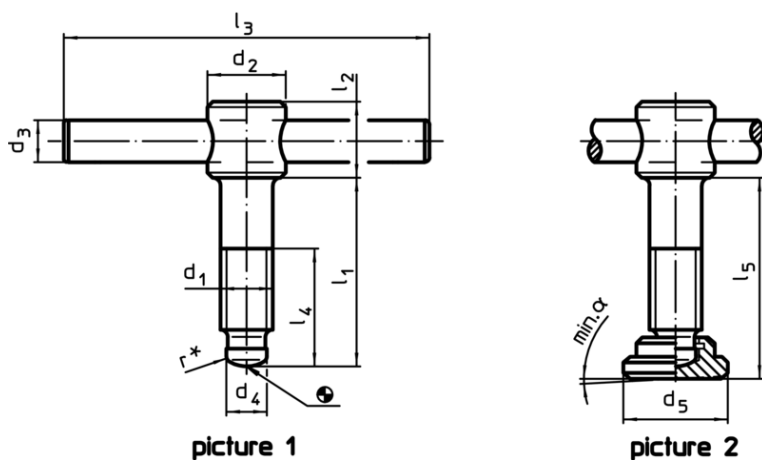

\* to ease assembly the DIN 6304 specification has been completed by r

### Order information

Dimensions								[g]	Art. No.
d <sub>1</sub>	l <sub>1</sub>	d <sub>2</sub>	d <sub>3</sub>	d <sub>4</sub>	l <sub>2</sub>	l <sub>3</sub>	l <sub>4</sub>		
without thrust pad, form E – picture 1									
M10	70	18	8	8	14	80	50	86	24490.0011