

Adjustable Clamping Levers

24440.0224



Product Description

Material

Lever

- Steel, blackened

Inner parts

- Steel, blackened, quality 5.8

Screw

- Steel, blackened, quality 5.8

Ball knob

- Thermosetting plastic PF 31, black, DIN 319

Operation

By lifting the lever the serrations are disengaged. The lever can be positioned by the serrations. On releasing the lever, the serrations are automatically re-engaged.

More information

Notes

The threaded portion can be exchanged.

Drawing

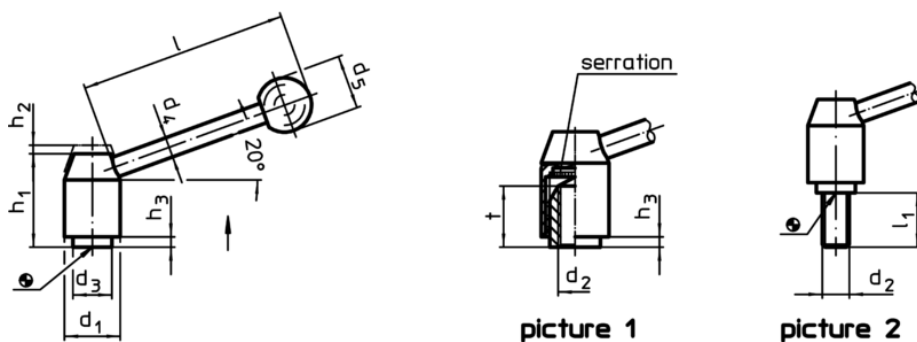

Order information

Dimensions										[g]	Art. No.
d ₁	d ₂	l ₁	d ₃	d ₄	d ₅	h ₁	h ₂	h ₃	l		
[mm]											
with screw – picture 2, Steel											
24	M10	25	16	10	25	40	4,5	2,5	96	174	24440.0224