

Adjustable Clamping Levers

24440.0128



Product Description

Material

Lever

- Steel, blackened

Inner parts

- Steel, blackened, quality 5.8

Screw

- Steel, blackened, quality 5.8

Ball knob

- Thermosetting plastic PF 31, black, DIN 319

Operation

By lifting the lever the serrations are disengaged. The lever can be positioned by the serrations. On releasing the lever, the serrations are automatically re-engaged.

More information

Notes

The threaded portion can be exchanged.

Drawing

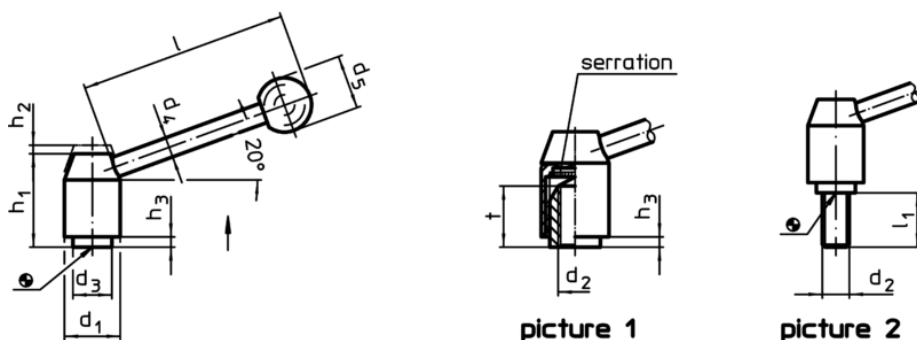

Order information

d ₁	d ₂	l ₁	d ₃	Dimensions				h ₁	h ₂	h ₃	l	[g]	Art. No.
				d ₄	d ₅	[mm]							
with screw – picture 2, Steel													
21	M8	32	13,5	8	20	33,5	4	1	70	105	24440.0128		