

## Adjustable Clamping Levers

24440.0126



### Product Description

#### Material

##### Lever

- Steel, blackened

##### Inner parts

- Steel, blackened, quality 5.8

##### Screw

- Steel, blackened, quality 5.8

##### Ball knob

- Thermosetting plastic PF 31, black, DIN 319

#### Operation

By lifting the lever the serrations are disengaged. The lever can be positioned by the serrations. On releasing the lever, the serrations are automatically re-engaged.

#### More information

#### Notes

The threaded portion can be exchanged.

### Drawing

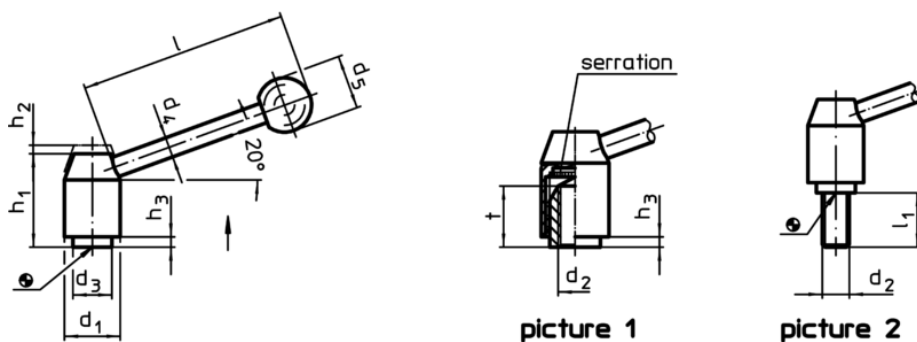

### Order information

d <sub>1</sub>	d <sub>2</sub>	l <sub>1</sub>	d <sub>3</sub>	Dimensions				h <sub>1</sub>	h <sub>2</sub>	h <sub>3</sub>	l	[g]	Art. No.
				d <sub>4</sub>	d <sub>5</sub>	[mm]							
with screw – picture 2, Steel													
21	M8	25	13,5	8	20	33,5	4	1	70	102	24440.0126		