

## Adjustable Clamping Levers with screw

24400.0271



### Product Description

#### Material

##### Lever

- Zinc die-cast, plastic coated, orange similar to RAL 2004, matt structure

##### Inner parts

- Steel, blackened, quality 5.8

##### Screw

- Steel, blackened, quality 5.8

#### Operation

**By lifting the lever** the serrations are disengaged. The lever can be positioned by the serrations. On releasing the lever, the serrations are automatically re-engaged.

#### More information

#### Notes

The screw part can be exchanged.

### Drawing

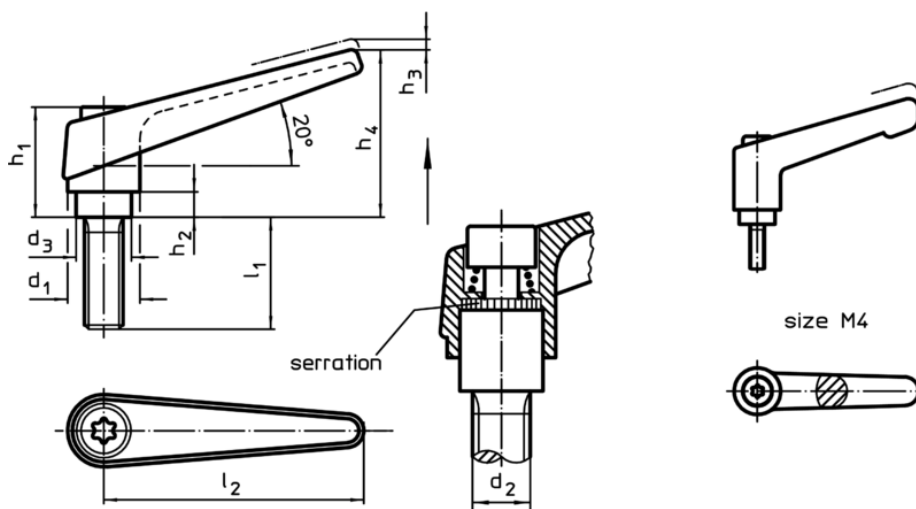

### Order information

Dimensions										[g]	Art. No.
$d_1$	$d_2$	$l_1$	$d_3$	$h_1$	$h_2$	$h_3$	$h_4$	$l_2$	[mm]		
orange											
18	M6	50	13,5	31	6,5	3	45	62		76	24400.0271

### Application example

