

Adjustable Clamping Levers• inner parts from stainless steel, with female thread

24390.0624



Product Description

Adjustable clamping levers with rust-proof inner parts. Suitable for multiple applications, e.g. medical environments, chemical industry, and so on.

Material

Lever

- Zinc die-cast, plastic coated, black, similar to RAL 9005, matt structure

Threaded part

- Stainless steel 1.4305

Inner parts

- Stainless steel 1.4305

Operation

By lifting the lever the serrations are disengaged. The lever can be positioned by the serrations. On releasing the lever, the serrations are automatically re-engaged.

More information

Notes

The threaded portion can be exchanged.

Drawing

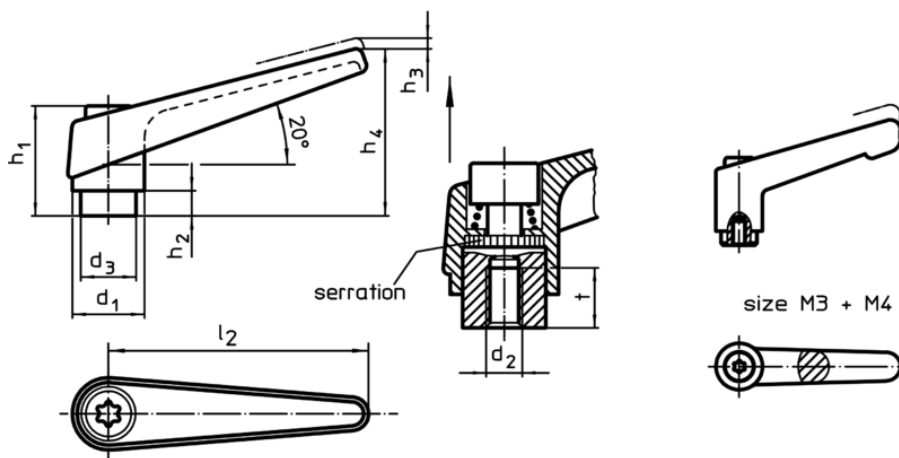

Order information

Dimensions										[g]	Art. No.
d ₁	d ₂	d ₃	h ₁	h ₂	h ₃	h ₄	l ₂	t	≥		
[mm]											
black											
30	M16	23	50,5	12	5	76	108	22		269	24390.0624

Application example

