

Adjustable Clamping Levers• inner parts from stainless steel, with screw

24390.0571



Product Description

Adjustable clamping levers with rust-proof inner parts. Suitable for multiple applications, e.g. medical environments, chemical industry, and so on.

Material

Lever

- Zinc die-cast, plastic coated, orange similar to RAL 2004, matt structure

Inner parts

- Stainless steel 1.4305

Screw

- Stainless steel 1.4305

Operation

By lifting the lever the serrations are disengaged. The lever can be positioned by the serrations. On releasing the lever, the serrations are automatically re-engaged.

More information

Notes

The screw part can be exchanged.

Drawing

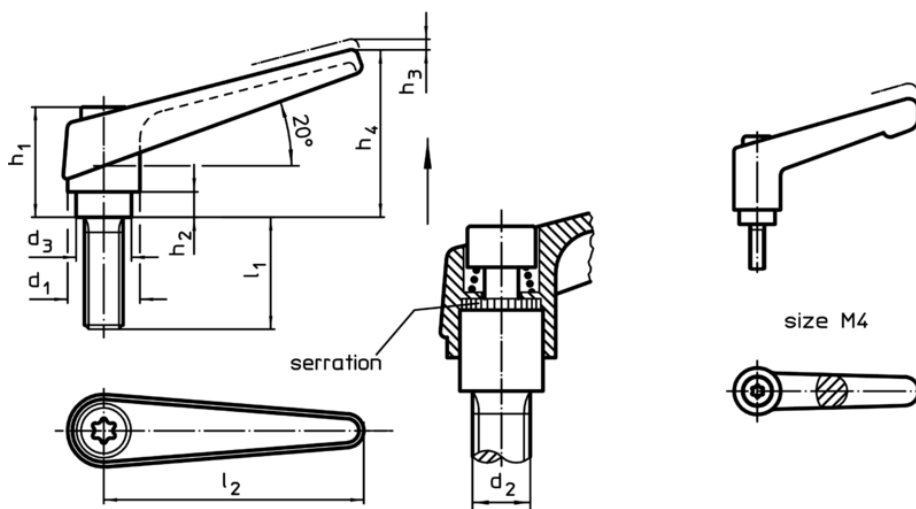

Order information

Dimensions										[g]	Art. No.
d_1	d_2	l_1	d_3	h_1	h_2	h_3	h_4	l_2	[mm]		
orange											
25	M12	50	19	43	11	4	63	89		222	24390.0571

Application example

