

## Adjustable Clamping Levers• inner parts from stainless steel, with screw

24390.0144



### Product Description

Adjustable clamping levers with rust-proof inner parts. Suitable for multiple applications, e.g. medical environments, chemical industry, and so on.

### Material

#### Lever

- Zinc die-cast, plastic coated, black, similar to RAL 9005, matt structure

#### Inner parts

- Stainless steel 1.4305

#### Screw

- Stainless steel 1.4305

### Operation

**By lifting the lever** the serrations are disengaged. The lever can be positioned by the serrations. On releasing the lever, the serrations are automatically re-engaged.

### More information

### Notes

The screw part can be exchanged.

### Drawing

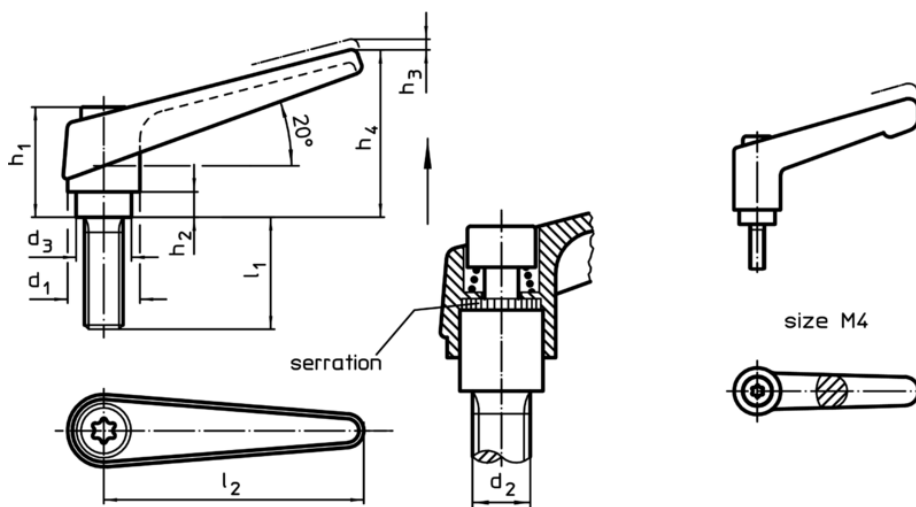

### Order information

Dimensions										[g]	Art. No.
d <sub>1</sub>	d <sub>2</sub>	l <sub>1</sub>	d <sub>3</sub>	h <sub>1</sub>	h <sub>2</sub>	h <sub>3</sub>	h <sub>4</sub>	l <sub>2</sub>			
black											
14	M6	16	10	24,5	4	3	35	45	37	24390.0144	

Application example

