

## Adjustable Clamping Levers• inner parts from stainless steel, with screw

24390.0026



### Product Description

Adjustable clamping levers with rust-proof inner parts. Suitable for multiple applications, e.g. medical environments, chemical industry, and so on.

### Material

#### Lever

- Zinc die-cast, plastic coated, orange similar to RAL 2004, matt structure

#### Inner parts

- Stainless steel 1.4305

#### Screw

- Stainless steel 1.4305

### Operation

**By lifting the lever** the serrations are disengaged. The lever can be positioned by the serrations. On releasing the lever, the serrations are automatically re-engaged.

### More information

### Notes

The screw part can be exchanged.

### Drawing

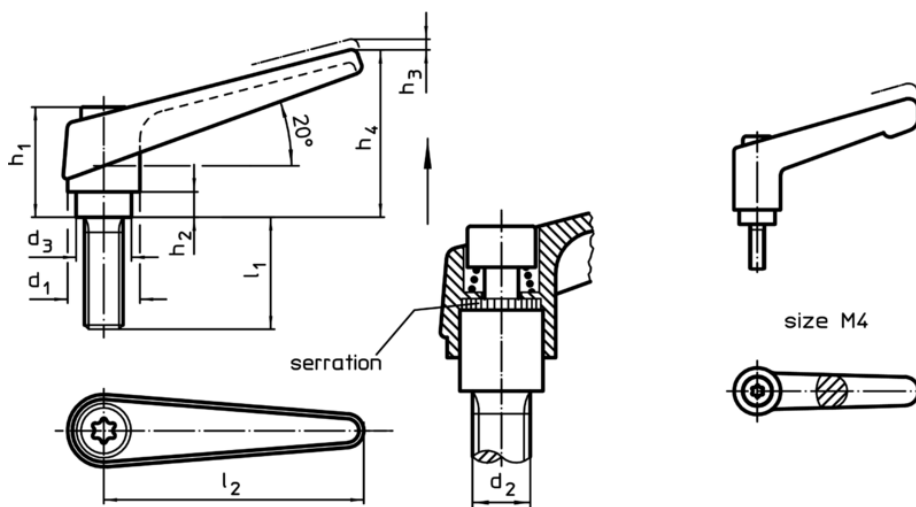

### Order information

Dimensions										Art. No.
$d_1$	$d_2$	$l_1$	$d_3$	$h_1$	$h_2$	$h_3$	$h_4$	$l_2$	[g]	
orange										
13	M4	32	10	24,5	4	3,5	30,5	30	29	24390.0026

Application example

