

## Gear Lever Handles

24350.0132



### Product Description

#### Material

##### Gear lever handle

- Steel, zinc-plated by galvanization, passivated

##### Ball knob

- Thermosetting plastic PF 31, black, DIN 319

##### Cylindrical handle

- Thermosetting plastic PF 31, black

### Drawing

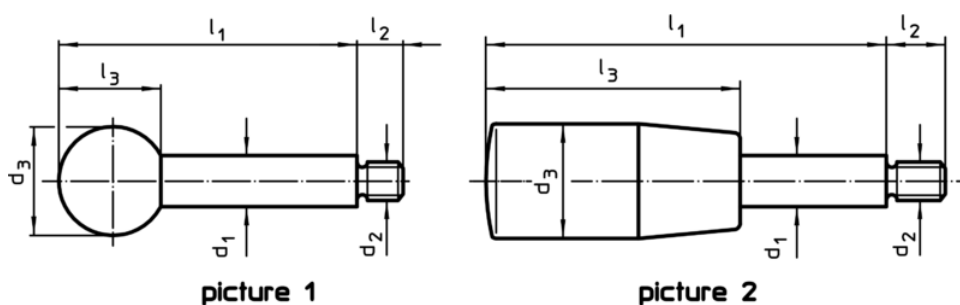

### Order information

Dimensions						max. [°C]	[g]	Art. No.
d <sub>1</sub>	l <sub>1</sub>	d <sub>2</sub> [mm]	d <sub>3</sub>	l <sub>2</sub>	l <sub>3</sub>			
with cylindrical handle – picture 2, Steel								
10	100	M8	21	11	50	110	62	24350.0132

### Application example

