

Gear Lever Handles

24350.0064



Product Description

Material

Gear lever handle

- Steel, zinc-plated by galvanization, passivated

Ball knob

- Thermosetting plastic PF 31, black, DIN 319

Cylindrical handle

- Thermosetting plastic PF 31, black

Drawing

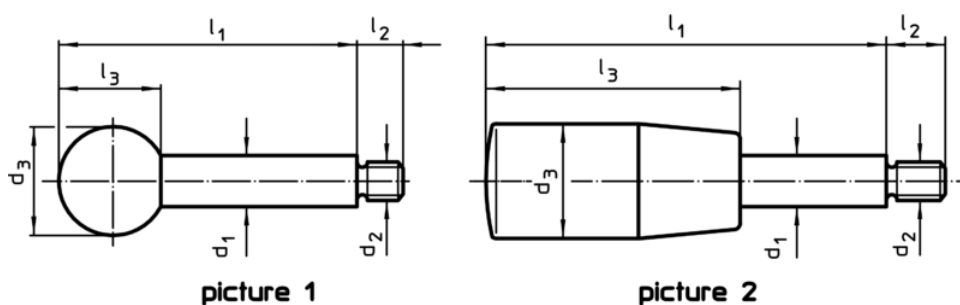

Order information

Dimensions						max. [°C]	[g]	Art. No.
d ₁	l ₁	d ₂ [mm]	d ₃	l ₂	l ₃			
with spherical knob – picture 1, Steel								
16	250	M14	40	18	37	110	397	24350.0064

Application example

