

Gear Lever Handles

24350.0062



Product Description

Material

Gear lever handle

- Steel, zinc-plated by galvanization, passivated

Ball knob

- Thermosetting plastic PF 31, black, DIN 319

Cylindrical handle

- Thermosetting plastic PF 31, black

Drawing

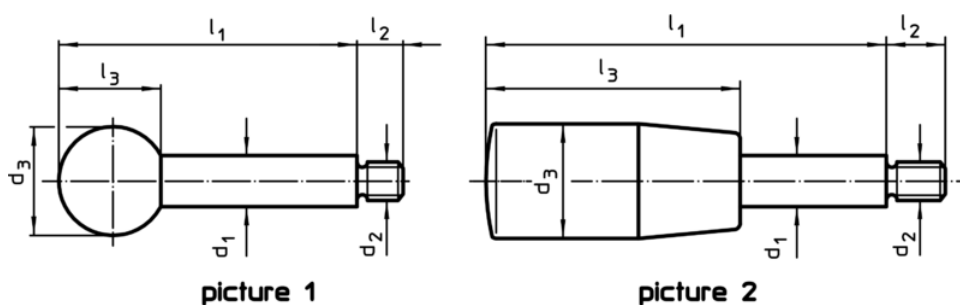

Order information

Dimensions						max. [°C]	[g]	Art. No.
d ₁	l ₁	d ₂ [mm]	d ₃	l ₂	l ₃			
with spherical knob – picture 1, Steel								
16	200	M14	40	18	37	110	326	24350.0062

Application example

