

Crank Handles

24330.0420



Product Description

Material

Handle body

- Zinc die-cast, plastic coated, black, matt structure

Cylindrical handle

- Thermosetting plastic PF 31, black

More information

References

Alternative to crank handles DIN 469.

Drawing

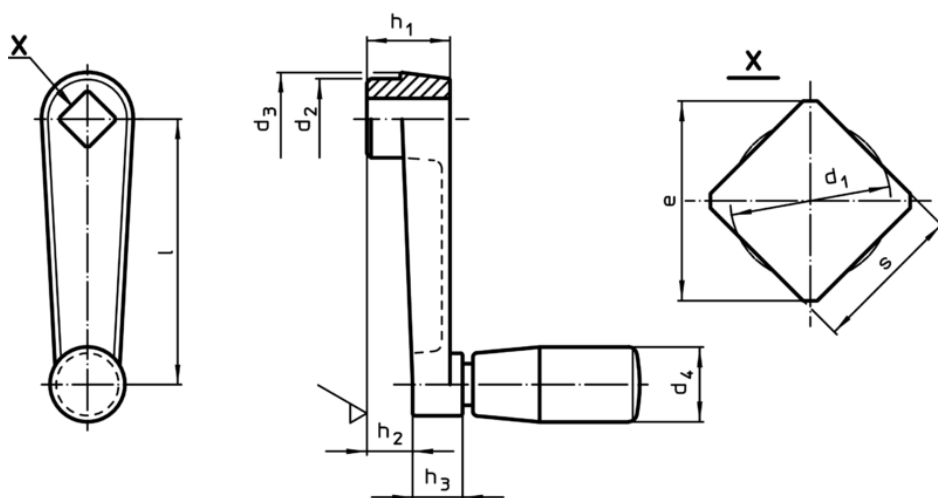

Order information

Dimensions									d_4			Art. No.
l	s	e	d_1	d_2	d_3	h_1	h_2	h_3	Cylindrical handle Ø	max.		
[mm]									[mm]	[°C]	[g]	
50	8	10,1	8,4	16	18	18	10	10	EH 24530.	80	58	24330.0420

Zinc die-cast

Application example

