

Crank Handles· DIN 468 goose-neck form with square end DIN 79

24330.0381



Product Description

With these crank handles, the seam is ground and blasted. The hub is machined.

Material

Machine handle

- Steel, turned, zinc-plated by galvanization, passivated

Handle body

- Nodular cast iron, plastic coated, black

Drawing

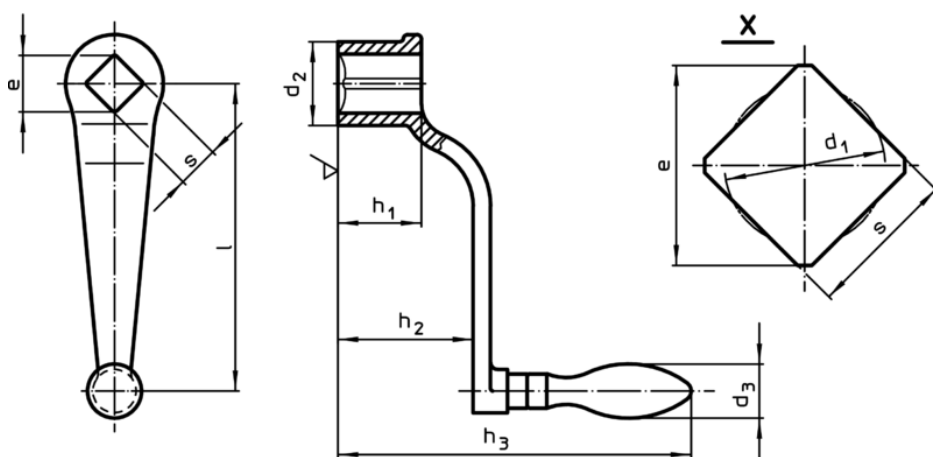

Order information

l	s H11	e min.	Dimensions					d ₃ Machine handle Ø [mm]	[g]	Art. No.
			d ₁ [mm]	d ₂ [mm]	h ₁ [mm]	h ₂ [mm]	h ₃ [mm]			
with mounted machine handle EH 24450., DIN 39										
315	27	36,2	28,4	54	54	105	243	36	2100	24330.0381