

Crank Handles• DIN 468 goose-neck form with square end DIN 79

24330.0331



Product Description

With these crank handles, the seam is ground and blasted. The hub is machined.

Material

Machine handle

- Steel, turned, zinc-plated by galvanization, passivated

Handle body

- Nodular cast iron, plastic coated, black

Drawing

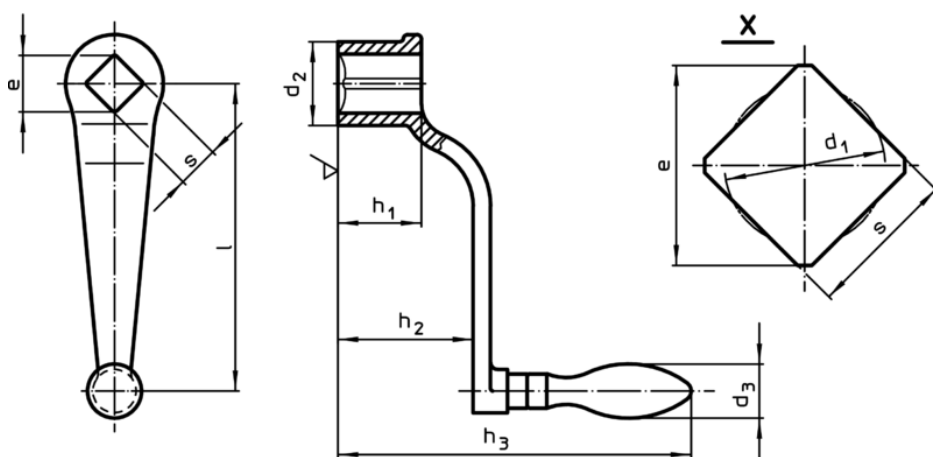

Order information

l	s H11	e min.	Dimensions					d ₃ Machine handle Ø	[g]	Art. No.
			d ₁	d ₂	h ₁	h ₂ ~	h ₃			
with mounted machine handle EH 24450., DIN 39										
100	14	18,1	14,7	28	28	48	124	20	292	24330.0331