

Crank Handles• DIN 468 goose-neck form with square end DIN 79

24330.0321



Product Description

With these crank handles, the seam is ground and blasted. The hub is machined.

Material

Machine handle

- Steel, turned, zinc-plated by galvanization, passivated

Handle body

- Nodular cast iron, plastic coated, black

Drawing

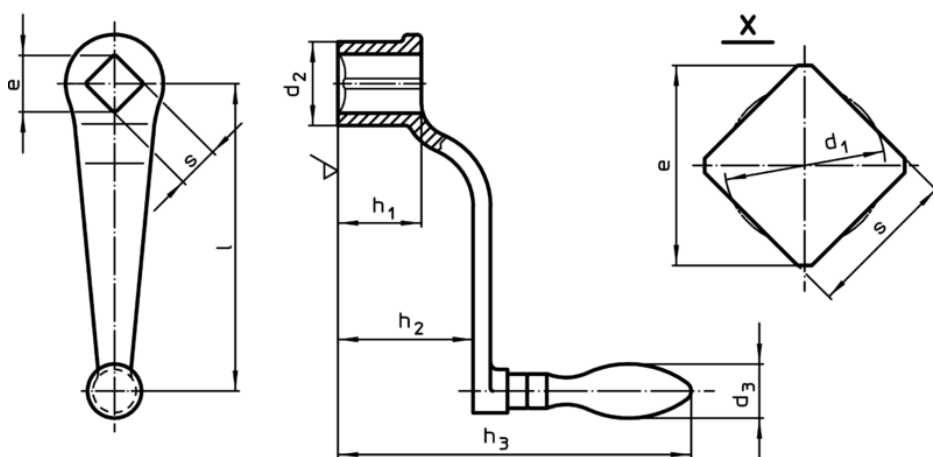

Order information

l	s H11	e min.	Dimensions					d ₃ Machine handle Ø [mm]	[g]	Art. No.
			d ₁ [mm]	d ₂	h ₁	h ₂ ~	h ₃			
with mounted machine handle EH 24450., DIN 39										
80	12	16,1	12,6	24	24	38	114	18	183	24330.0321