

Crank Handles• DIN 469 straight, with square end DIN 79
24330.0161



Product Description

With these crank handles, the seam is ground and blasted. The hub is machined.

Material

Machine handle

- Steel, turned, zinc-plated by galvanization, passivated

Handle body

- Nodular cast iron, plastic coated, black

Drawing

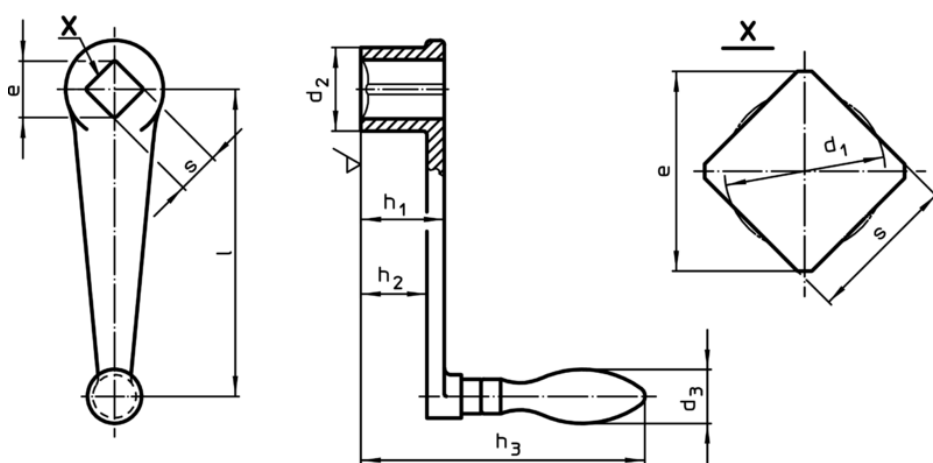

Order information

l	s H11	e min.	Dimensions					d ₃ Machine handle Ø	[g]	Art. No.
			d ₁	d ₂	h ₁	h ₂	h ₃			
			[mm]					[mm]		
with mounted machine handle EH 24450., DIN 39										
200	22	28,2	23,1	44	44	34	154	28	983	24330.0161