

U-Handles· Plastic

24320.0220

Product Description



Material

Bushing
• Brass

Handle

• Thermoplastic PA, glass-fibre reinforced,
black

Assembly

Back mount handle.

Drawing

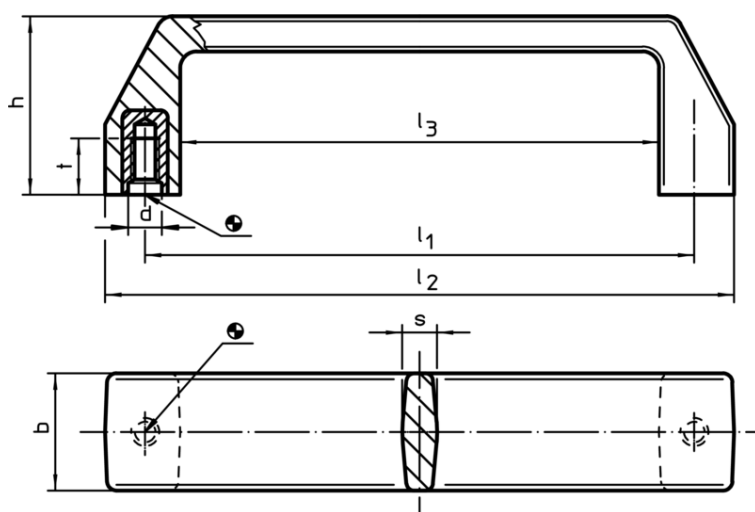

Order information

Dimensions								max. [°C]	[g]	Art. No.
l_1 $\pm 0,5$	d	b	h	l_2	l_3	s	t			
[mm]										
117	M6	25	38	134	102	7,5	12	100	57	24320.0220

Application example

