

U-Handles with support washer

24310.0560



Product Description

Material

- Handle**
- Stainless steel 1.4305, dull blasted
- Support washer**
- Stainless steel

Assembly

The supporting washer provides a good surface. Suitable washers are joined in loose form.

Drawing

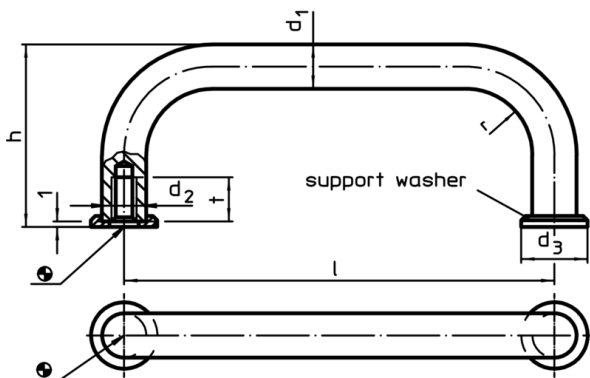

Order information

d ₁	l ±0,5	d ₂	Dimensions				t min.	[g]	Art. No.
			d ₃	h	r	[mm]			
Stainless steel									
8	120	M4	12	35	10	8	66	24310.0560	