

U-Handles with support washer

24310.0120

Product Description



Material

Handle

- Steel, chromium-plated

Support washer

- Zinc die-cast, nickel-plated

Assembly

The supporting washer provides a good surface. Suitable washers are joined in loose form.

Drawing

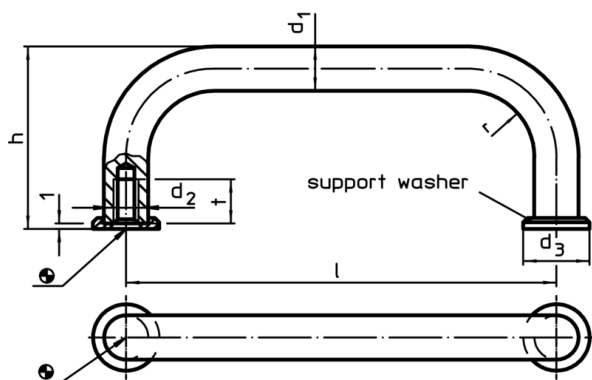

Order information

d ₁	l ±0,5	d ₂	Dimensions				t min.	[g]	Art. No.
			d ₃	h	r	[mm]			
Steel									
10	88	M5	15	43	12	12	91	24310.0120	