

U-Handles with support washer

24310.0060

Product Description



Material

Handle

- Steel, chromium-plated

Support washer

- Zinc die-cast, nickel-plated

Assembly

The supporting washer provides a good surface. Suitable washers are joined in loose form.

Drawing

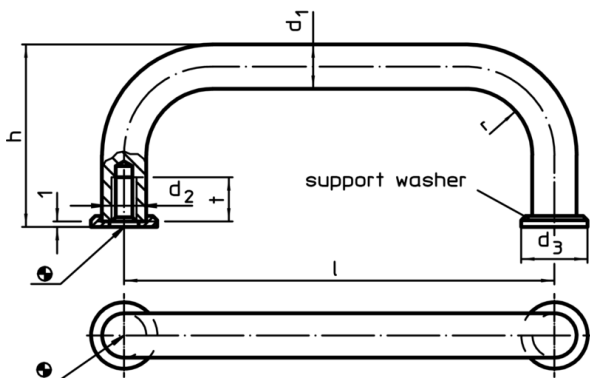

Order information

d_1	l $\pm 0,5$	d_2	Dimensions d_3 [mm]	h	r	t min.	 [g]	Art. No.
8	120	M4	12	35	10	8	66	24310.0060