

Eccentric Quick Clamps• with screw

23390.0123



Product Description

For quick and easy clamping and releasing of workpieces.
When using the "adjustable" design (picture 2) the lever position can be moved.

Material

Support washer

- Thermoplastic POM, glass-fiber reinforced

Lever

- Zinc die-cast, plastic coated, black

Inner parts

- Steel, zinc-plated by galvanization

Screw

- Steel, zinc-plated by galvanization

Adjusting nut

- Steel, zinc-plated by galvanization

Drawing

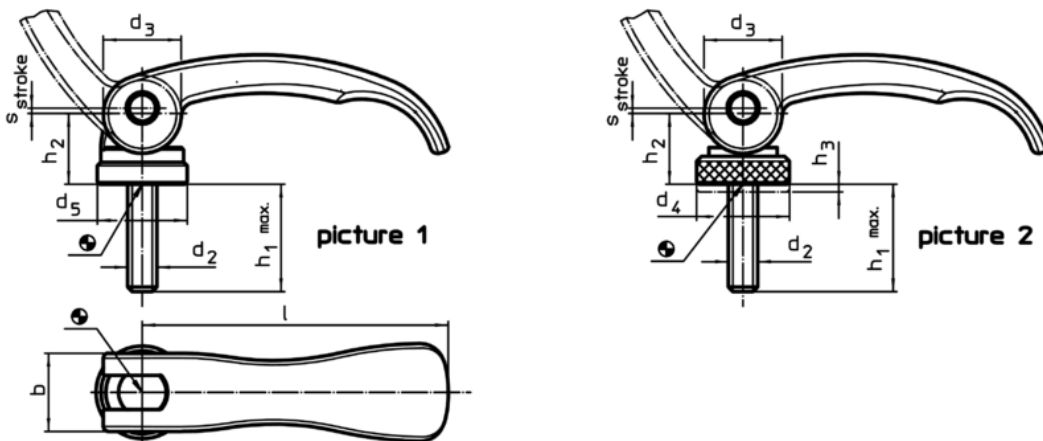

Order information

l	d ₂	h ₁ max. in clamping position	Dimensions					Regulating- range h ₃ min.	b	Stroke s at 90° lever position [mm]	max. [°C]	Regulating- range h ₃ min. [g]	Art. No.
			d ₃	d ₄	h ₂ max.	[mm]							
with screw, adjustable – picture 2, Steel													
82	M8	40	20	25	19,5	2,5	20	1	80	149	23390.0123		

Application example

