

## Eccentric Quick Clamps• with screw

23390.0034



### Product Description

For quick and easy clamping and releasing of workpieces.  
When using the "adjustable" design (picture 2) the lever position can be moved.

### Material

#### Support washer

- Thermoplastic PA, glass-fiber reinforced

#### Lever

- Zinc die-cast, plastic coated, black

#### Inner parts

- Steel, zinc-plated by galvanization

#### Screw

- Steel, zinc-plated by galvanization

#### Adjusting nut

- Steel, zinc-plated by galvanization

### Drawing

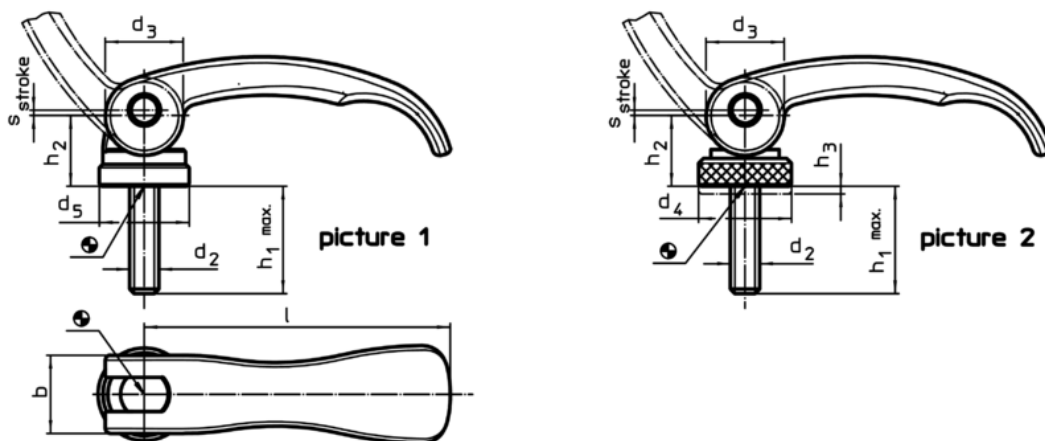

### Order information

Dimensions							Stroke s at 90° lever position	🌡️ max.	🏋️ [g]	Art. No.
l	d <sub>2</sub>	h <sub>1</sub> max. in clamping position	d <sub>3</sub>	d <sub>5</sub>	h <sub>2</sub> max.	b	[mm]	[°C]	[g]	
with screw – picture 1, Steel										
63	M5	35	16	18,5	16,4	16	0,75	80	65	23390.0034

### Application example

