

Eccentric Quick Clamps• with screw

23390.0014



Product Description

For quick and easy clamping and releasing of workpieces.
When using the "adjustable" design (picture 2) the lever position can be moved.

Material

Support washer

- Thermoplastic PA, glass-fiber reinforced

Lever

- Zinc die-cast, plastic coated, black

Inner parts

- Steel, zinc-plated by galvanization

Screw

- Steel, zinc-plated by galvanization

Adjusting nut

- Steel, zinc-plated by galvanization

Drawing

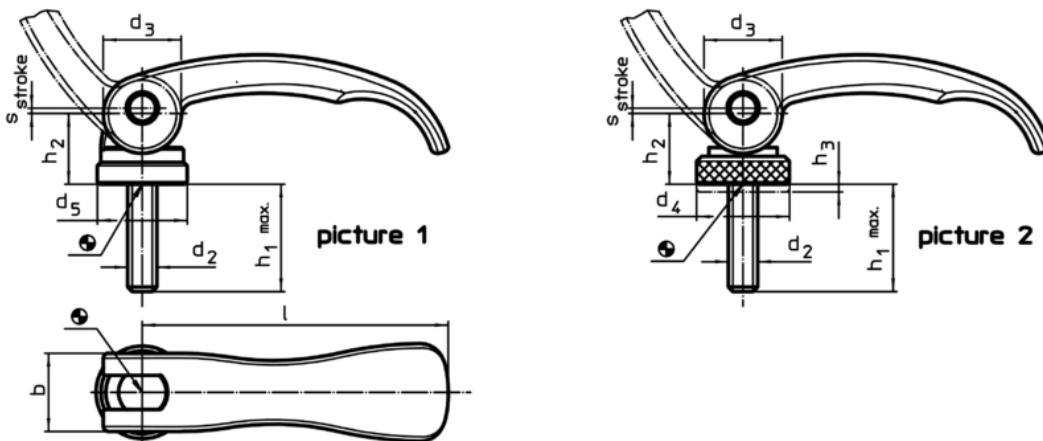

Order information

Dimensions							Stroke s at 90° lever position [mm]	🌡️ max. [°C]	🏋️ [g]	Art. No.
l	d ₂	h ₁ max. in clamping position	d ₃	d ₅	h ₂ max.	b				
with screw – picture 1, Steel										
63	M6	40	16	18,5	16,4	16	0,75	80	68	23390.0014

Application example

