

Down-Thrust Clamps · size 40

23310.0056



Product Description

Universal mechanical clamping element for fast and comfortable changing and clamping of workpieces by means of manually swivelling clamping claw.

The down-thrust clamps provide the following advantages:

- rapid manual clamping, by means of the clamping screw, adjustable clamping lever or double eccentric lever
- easy and quick changing of the workpiece by swinging the clamping head to the left or right; continuously variable setting by means of positioning ring 23310.0350
- when using a positioning ring 23310.0350 a repeatable precise clamping is ensured; h_2 will then be increased by 7 mm (s minus 7 mm)
- reduced space requirements due to compact design
- easy adaptation even to large clamping heights by means of height adjusting cylinders

Material

- Case-hardened steel, case-hardened, blackened and ground

Assembly

Down-thrust clamps can be fastened in two different ways:

1. with a nut for T-slots (DIN 508)
2. with a set screw directly in the mounting plate e.g. of a fixture

The cylinder has to rest on the entire surface. Exceeding of the clamping height is inhibited by the height limitation.

More information

References

The clamping height can be increased by using height adjusting cylinders EH 23310. and disks EH 1107. and EH 1108. It can be reduced by employing clamping inserts, e.g. EH 22730.

Further products

- Positioning Rings, For down-thrust clamp
- Height Adjusting Cylinders
- Spacers
- Wrenches

Drawing

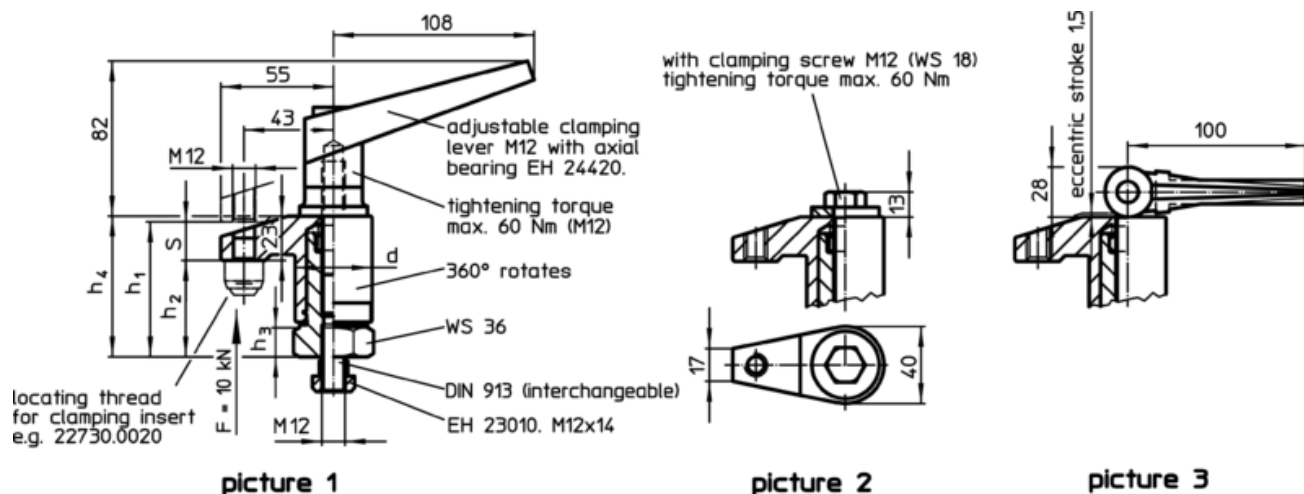

Order information

d	h ₁ max.	Dimensions			h ₄	s Stroke [mm]	[g]	Art. No.
		h ₂ min.	h ₃ [mm]					
with adjustable clamping lever with axial bearing – picture 1								
40	135	95	22		118 – 158	40	1639	23310.0056

Application example

