

Stops• cylindrical
23280.0216



Product Description

The T-slot guide enables a quick and precise location of the workpiece. The cylindrical form of the stop facilitates to determine the 0-point coordinate. The short form, which is ground to a height tolerance of $\pm 0,01$ mm, can also be used for locating.

Material

Stop

- Steel, case-hardened, ground

Holding plate

- Steel, blackened

Screw

- Steel, quality 8.8 (ISO 4762)

Drawing

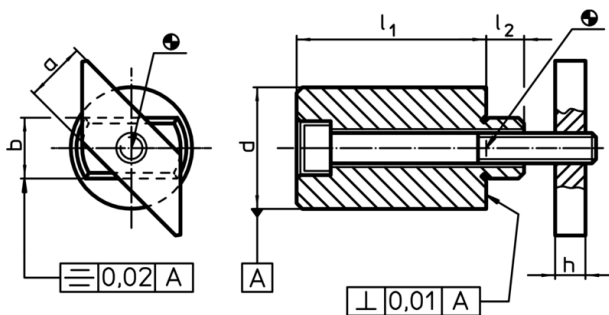

Order information

T-slot size h6 [mm]	l_1 $\pm 0,2$	a -0,6	Dimensions d $\pm 0,01$ [mm]			h	l_2	Screw ISO 4762 [mm]	 [g]	Art. No.
16	50	16	32	8	10	M8 x 70	371	23280.0216		

Application example

