

Holding Plates• for down-hold clamps

23210.0780

Product Description

By using the holding plates, the down-hold clamps can also be placed in any desired position across the T-slots.

Material

- Heat-treated steel, tempered, blackened



Drawing

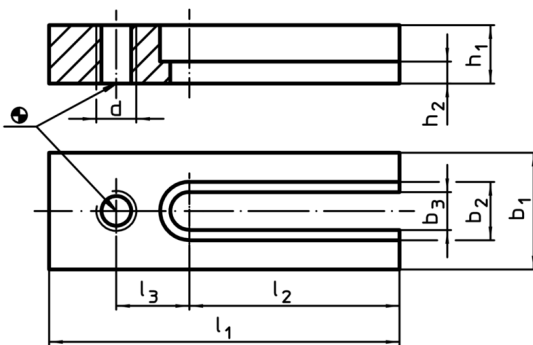

Order information

b ₁	b ₂	b ₃	d	Dimensions						[g]	Art. No.
				h ₁ -0,4 [mm]	h ₂	l ₁	l ₂	l ₃			
90	38	25	M24	50	24	220	130	55	5850	23210.0780	

Application example

