

Manual Handles• for positioning clamping pins

23111.0900

Product Description

The manual handle enables an easy and fast operation of the positioning clamping pin.

Material

- Stainless steel

Assembly

The handle is tightened to the positioning clamping pin with the M 4 screw included in the delivery.

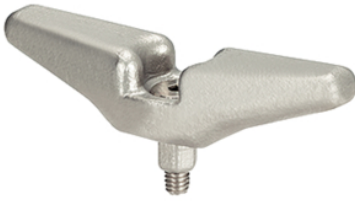

Drawing

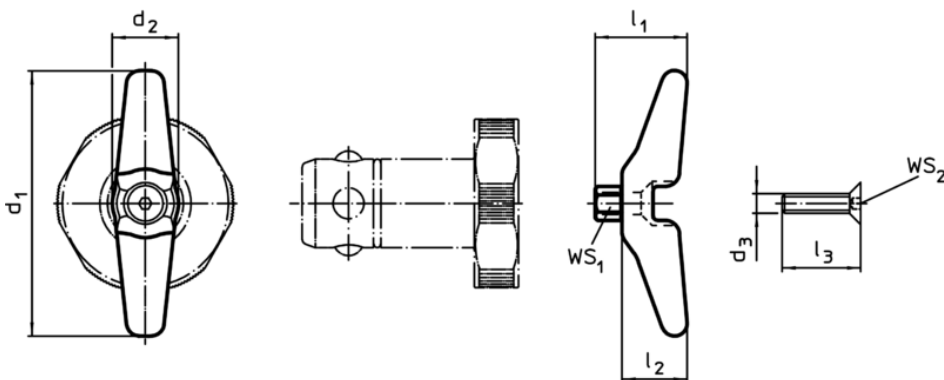

Order information

For pin Ø [mm]	Dimensions						WS ₁ [mm]	WS ₂ [mm]	[g]	Art. No.
	d ₁	d ₂	d ₃	l ₁	l ₂	l ₃				
16/20	60	15	M4	20	15	16	6	2,5	45	23111.0900

Application example

