

Bushings for positioning clamping pins

23111.0812



Product Description

Material

- Stainless steel 1.4112, hardened

Assembly

Two centering bushes and two floating bushes are to be mounted into the plate to be clamped in order to guarantee an optimal repeatability.

Characteristic

The floating bush has a groove that serves as a differentiation mark.

Drawing

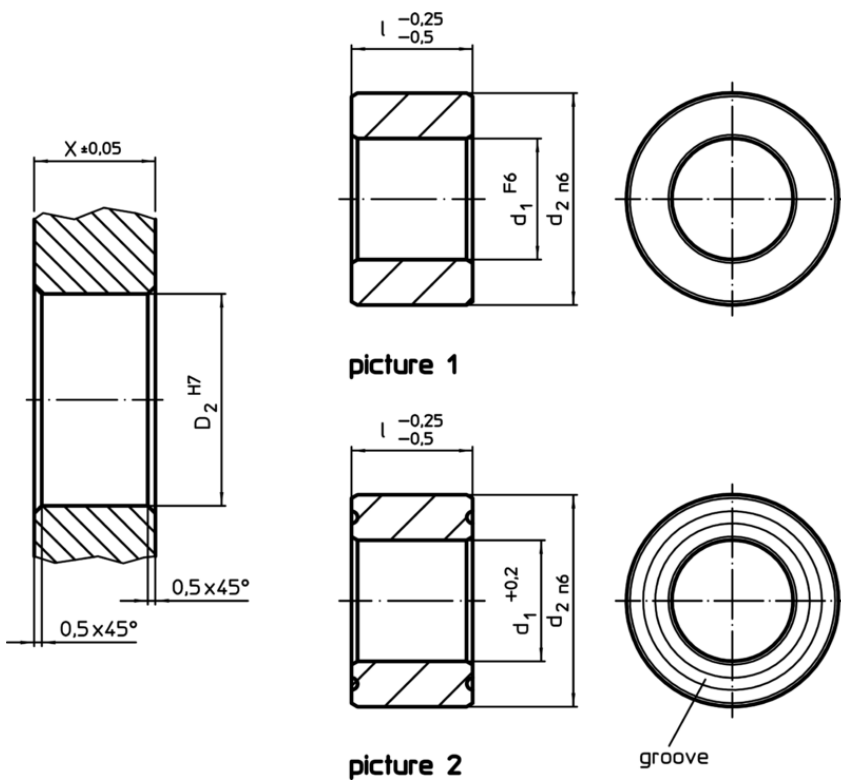

Order information

Dimensions		Location hole		[g]	Art. No.
d ₁	l	d ₂	X		
F6	-0,25 -0,5 [mm]	n6	±0,05 [mm]	H7	
central – picture 1, Stainless steel					
25	25	35	25	35	95 23111.0812

Application example

