

Bushings for positioning clamping pins

23111.0744



Product Description

Material

- Case-hardened steel, case-hardened, blackened

Assembly

Two centering bushes and two floating bushes are to be mounted into the plate to be clamped in order to guarantee an optimal repeatability.

Characteristic

The floating bush has a groove that serves as a differentiation mark.

Drawing

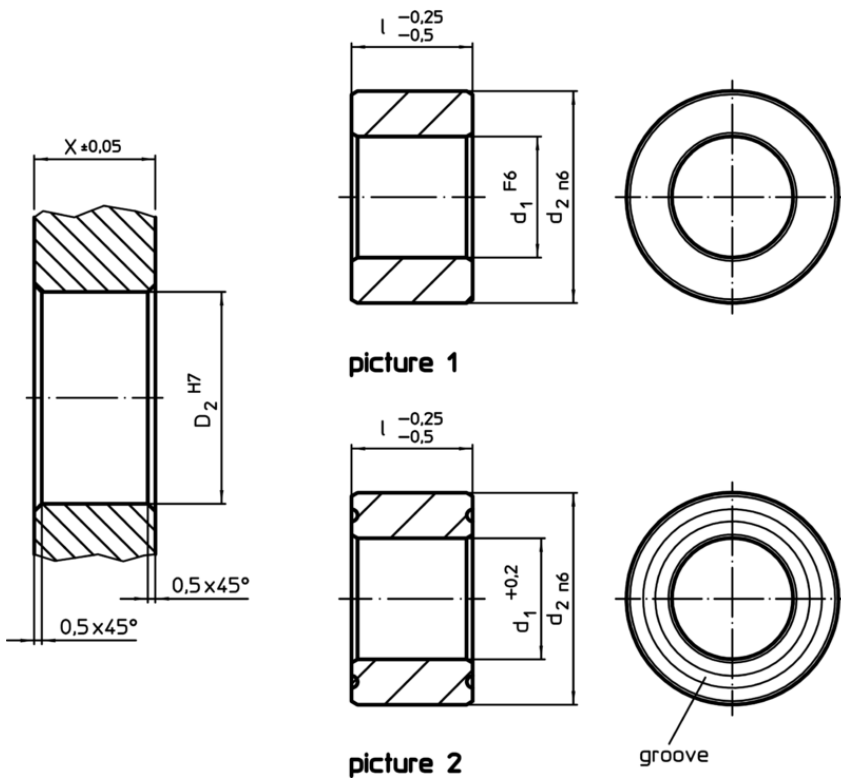

Order information

d ₁	Dimensions		d ₂	Location hole		[g]	Art. No.
	l	[mm]		X	D ₂		
+0,2	-0,25 -0,5	[mm]	n6	±0,05	H7		
floating – picture 2, Case-hardened steel							
30,8	20		45	20	45	135	23111.0744

Application example

