

Bushings for positioning clamping pins

23111.0742



Product Description

Material

- Case-hardened steel, case-hardened, blackened

Assembly

Two centering bushes and two floating bushes are to be mounted into the plate to be clamped in order to guarantee an optimal repeatability.

Characteristic

The floating bush has a groove that serves as a differentiation mark.

Drawing

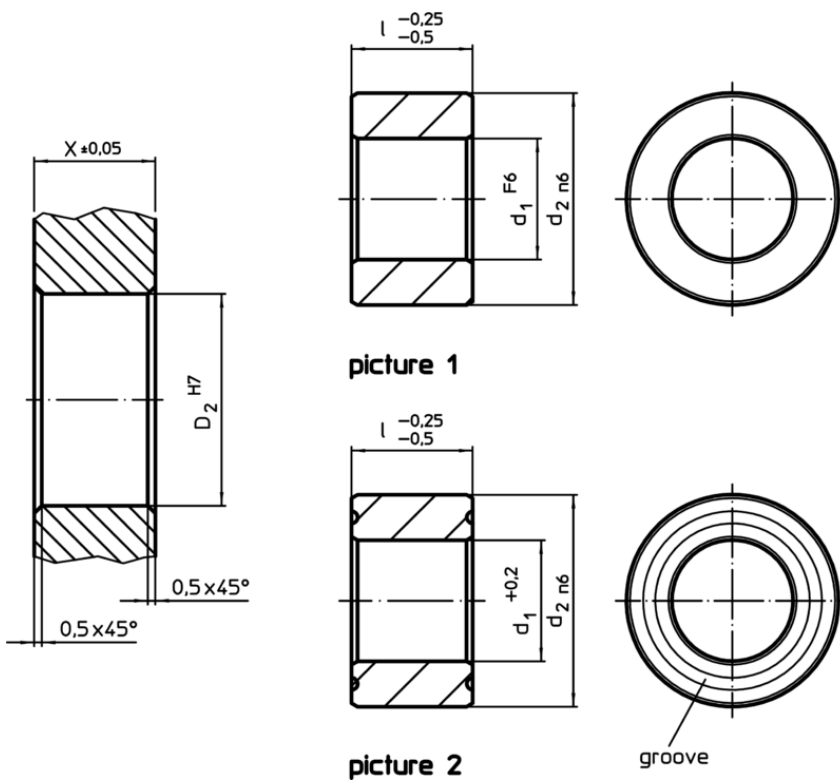

Order information

d ₁	Dimensions		d ₂	Location hole		[g]	Art. No.
	l	[mm]		X	D ₂		
+0,2	-0,25 -0,5	[mm]	n6	±0,05	H7		
floating – picture 2, Case-hardened steel							
25,8	25		35	25	35	85	23111.0742

Application example

