

## Bushings for positioning clamping pins

23111.0732



### Product Description

#### Material

- Case-hardened steel, case-hardened, blackened

#### Assembly

Two centering bushes and two floating bushes are to be mounted into the plate to be clamped in order to guarantee an optimal repeatability.

#### Characteristic

The floating bush has a groove that serves as a differentiation mark.

### Drawing

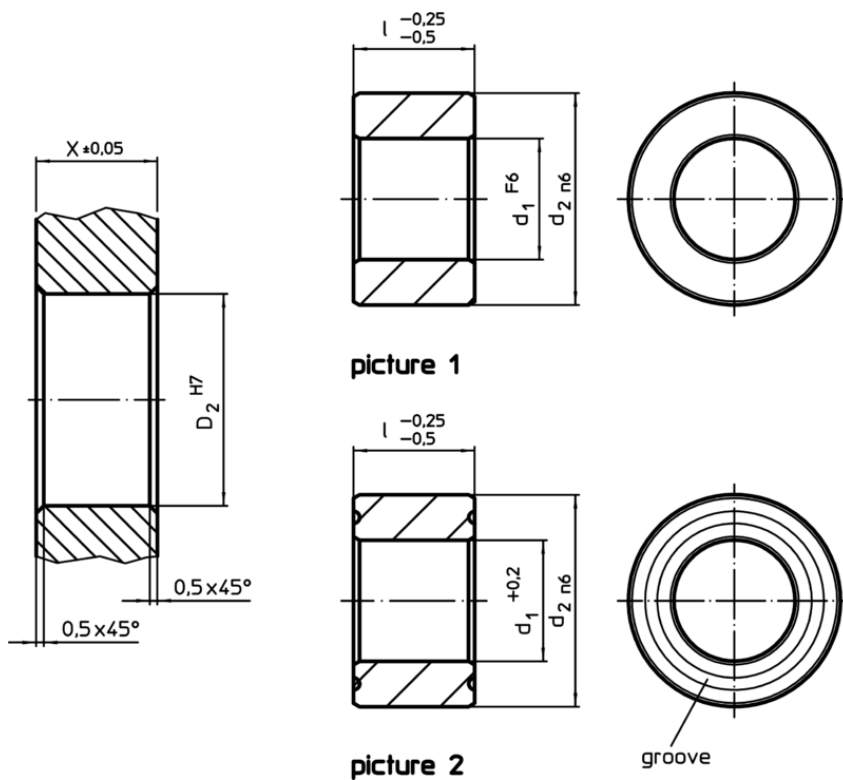

### Order information

d <sub>1</sub>	Dimensions		d <sub>2</sub>	Location hole		[g]	Art. No.
	l	[mm]		X	D <sub>2</sub>		
+0,2	-0,25 -0,5	[mm]	n6	±0,05	H7		
<b>floating – picture 2, Case-hardened steel</b>							
16,8	20		25	20	25	42	23111.0732

Application example

