

## Bushings for positioning clamping pins

23111.0716



### Product Description

#### Material

- Case-hardened steel, case-hardened, blackened

#### Assembly

Two centering bushes and two floating bushes are to be mounted into the plate to be clamped in order to guarantee an optimal repeatability.

#### Characteristic

The floating bush has a groove that serves as a differentiation mark.

### Drawing

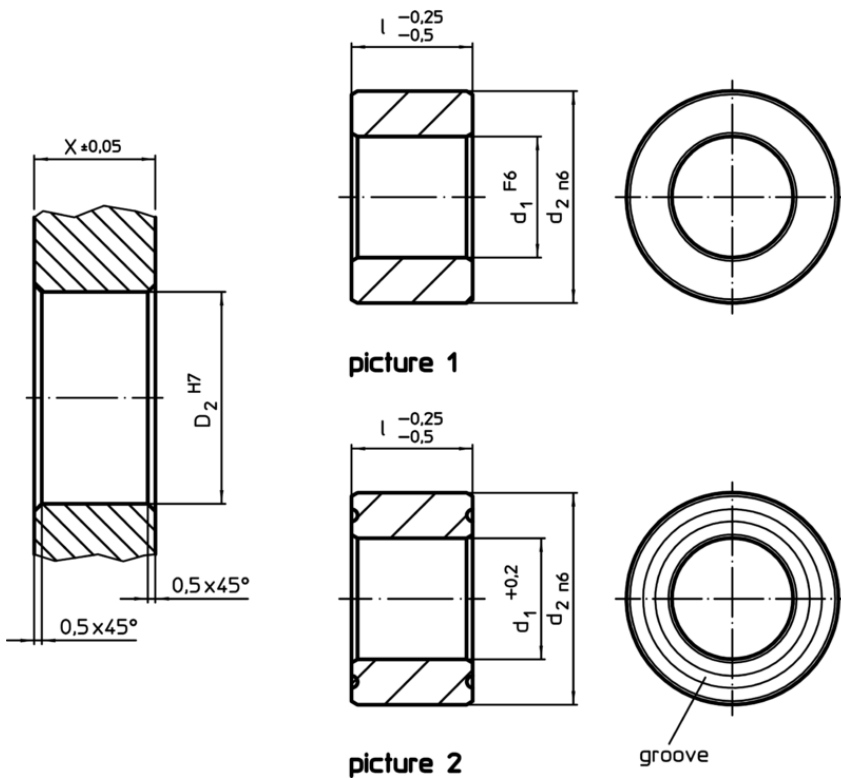

### Order information

d <sub>1</sub>	Dimensions l	d <sub>2</sub>	Location hole		D <sub>2</sub>	[g]	Art. No.
			X	[mm]			
F6	-0,25 -0,5 [mm]	n6	±0,05		H7		
central – picture 1, Case-hardened steel							
30	25	45	25		45	175	23111.0716

Application example

