

Positioning Clamping Pins

23111.0116



Product Description

The positioning clamping pin allows fast clamping, fastening, adjusting, changing and securing of workpieces, plates, fixture systems etc.

Material

- Stainless steel 1.4542, precipitation-hardened

Operation

By tightening the clamping screws, the positioning clamping pin is centered and clamped with four balls in the locating bush. The clamping screw can be operated manually via a removable handle (Art.-Nr. 23111.0900/.0902) or via an hex. key.

More information

Accessories

Suitable bushings are available.

Further products

- Manual Handles, for positioning clamping pins
- Bushings, for positioning clamping pins
- Locating Bushings, for positioning clamping pins, for press fit
- Locating Bushings, for positioning clamping pins, for screw fit

Drawing

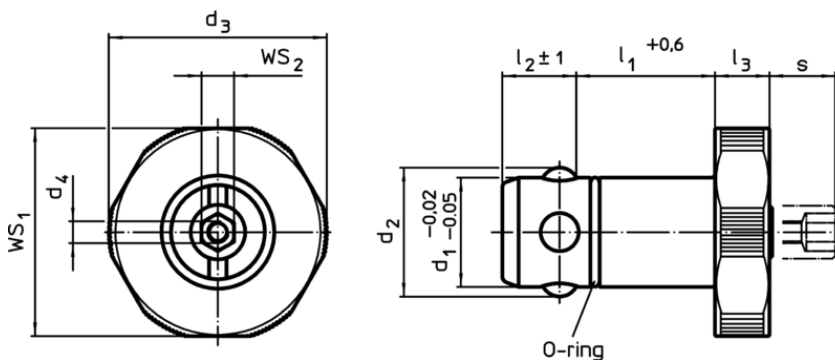

Order information

Dimensions									For base plates ±0,05	WS ₁	WS ₂	Holding force		Art. No.
d ₁	l ₁	d ₂	d ₃	d ₄	l ₂	l ₃	s	[mm]						
-0,02 -0,05	+0,6				±1		~							
Stainless steel														
16	25	18,7	32	M4	13,6	10	9	20	30	6	5	105	23111.0116	

Application example

