

Fixed Slot Tenons with cylindrical fastening

23110.0128



Product Description

To be used for locating fixtures and clamping elements onto mounting pallets or pallets with cylindrical location holes. They can be inserted in holes as well as in slots.

Material

- Steel, case-hardened, blackened, ground

Drawing

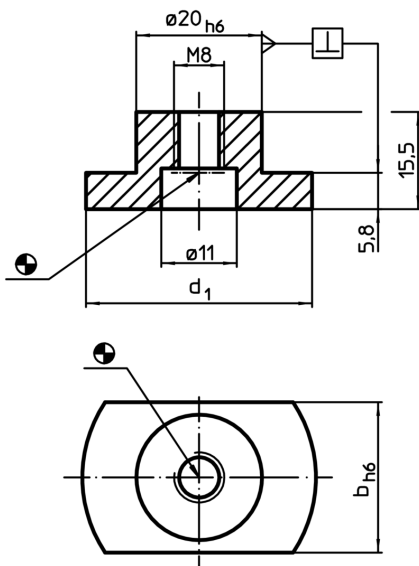

Order information

T-slot size machine b h6 [mm]	Dimensions d ₁ [mm]	For screws ISO 4762		[g]	Art. No.
		(picture 1) [mm]	(picture 2)		
28	42	M6 x 16	M8	65	23110.0128

Application example

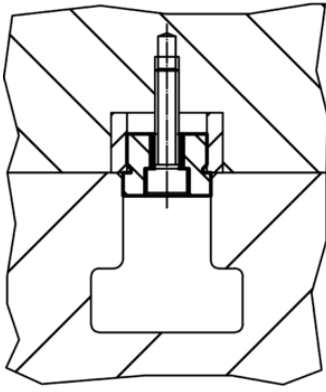

picture 1

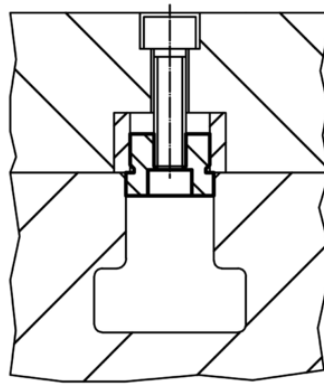

picture 2