

Fixed Slot Tenons

23110.0018

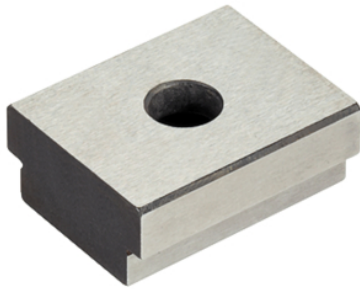

Product Description

To be used for locating fixtures and clamping elements onto machine tables with T-slots to DIN 650.

Material

- Steel, case-hardened, blackened, ground

More information

References

For size 20 refer to 23130.0020.

Drawing

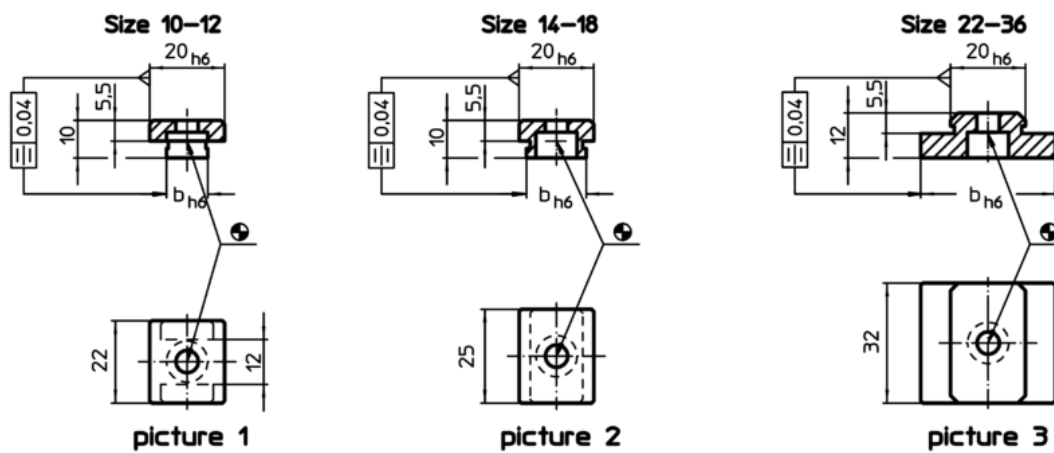

Order information

T-slot size machine b h6 [mm]	For screws ISO 4762 [mm]	 [g]	Art. No.
size 14-18 – picture 2			
18	M6 x 10	29	23110.0018

Application example

