

## Collar Nuts with Conical Seat

23080.0512



### Product Description

#### Material

##### Conical seat

- Heat-treated steel, tempered, blackened

##### Nut

- Heat-treated steel, tempered, blackened

#### More information

#### References

For torques and strengths please refer to appendix - Technical Data -

### Drawing

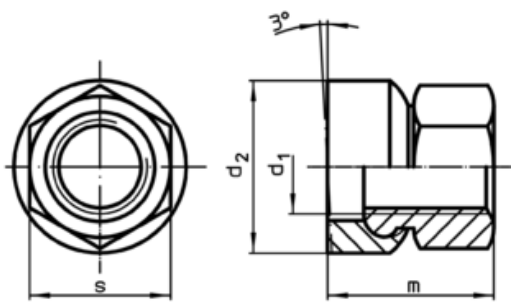

picture 1

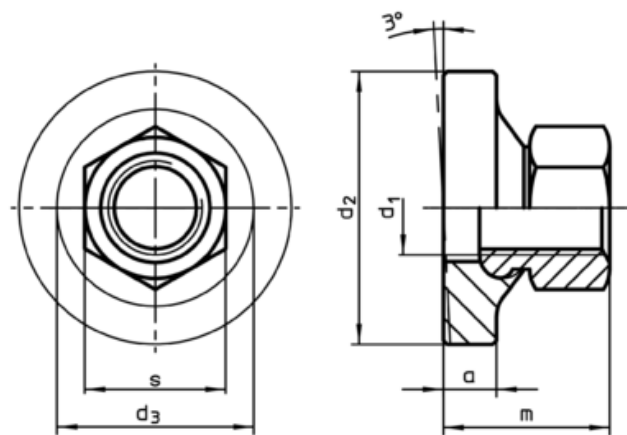

picture 2

### Order information

$d_1$	Dimensions $d_2$ [mm]	$m$ ~	$s$ [mm]	 [g]	Art. No.
with small surface – picture 1					
M12	24	21,5	18	38	23080.0512

Application example

