

Collar Nuts with Conical Seat

23080.0508



Product Description

Material

Conical seat

- Heat-treated steel, tempered, blackened

Nut

- Heat-treated steel, tempered, blackened

More information

References

For torques and strengths please refer to appendix - Technical Data -

Drawing

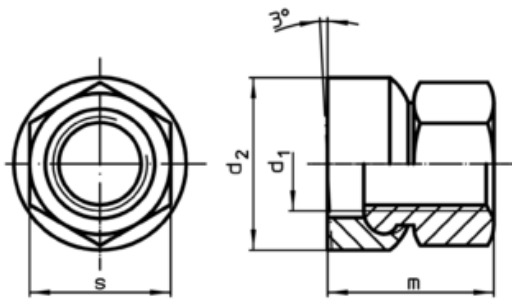

picture 1

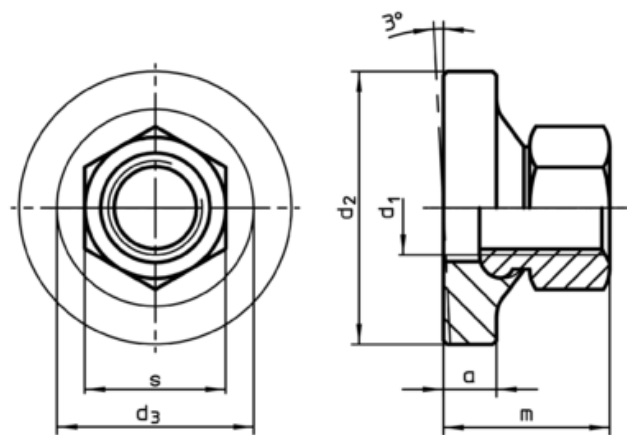

picture 2

Order information

d_1	Dimensions d_2 [mm]	m ~	s [mm]	 [g]	Art. No.
with small surface – picture 1					
M8	17	14	13	13	23080.0508

Application example

