

Spherical Washers / Conical Seats • similar to DIN 6319, stainless steel

23050.0724

Product Description



Material

- Conical seat**
- Stainless steel A4

Assembly

Conical seats form D are to be used only for plain, closed round areas.
For larger holes only use form G!

More information

Further products

- Spherical Washers / Conical Seats, DIN 6319
- Fixture Nuts, DIN 6330 (height 1,5 d)

Drawing

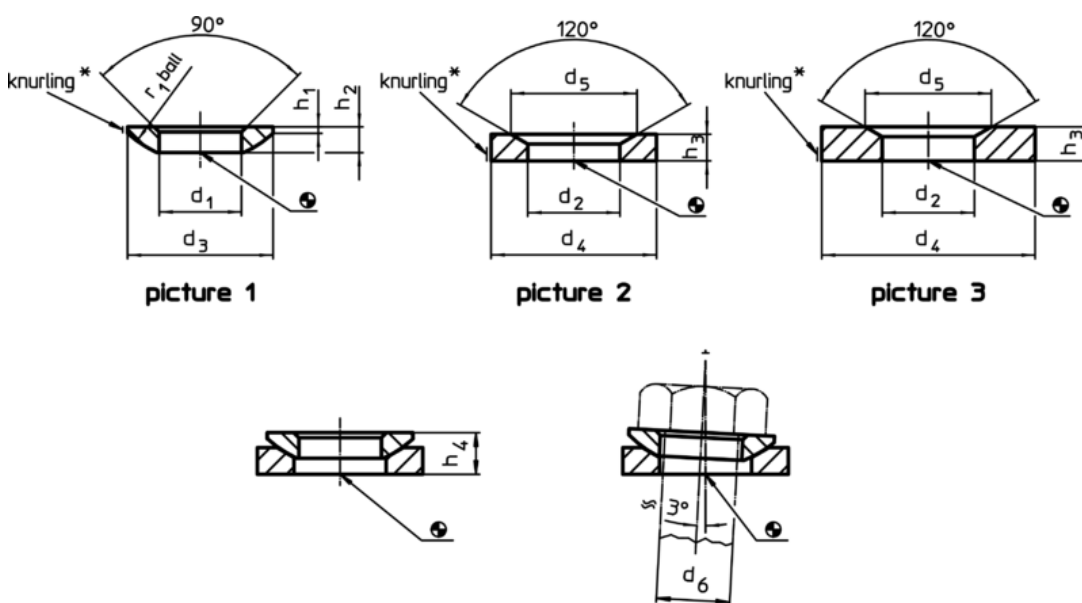

* Knurling = material identification for stainless steel A4 type

Order information

d ₂ H13	Dimensions			For pin d ₆ [mm]	For screws d ₆ [mm]	Load capacity for static load max. [kN]	Torque for screwed connections ¹⁾ max. [Nm]	[g]	Art. No.
	d ₄ [mm]	d ₅ [mm]	h ₃ [mm]						
conical seats from stainless steel, form G – picture 3, Stainless steel A4									
28	60	37	10	24	M24	105	455	171	23050.0724

¹⁾ Torques of screws A2-70 to be seen as very rough values only having information character; eventual pre-loads to be considered, coefficient of friction μ_{total} 0,12.

Application example

