

Setting Dies for Expander Sealing Plug

22880.0158

Product Description

Expander® sealing plugs are used for safe, quick and economic sealing of bore holes in fluid technology, e.g. hydraulic drilling holes in jig and fixture construction. Assembly is effected by pressing in the sealing plug into the drilling hole by means of the prescribed setting die.
Please refer to the technical data following these product information pages.

Material

- Tool steel, heat-treated



Drawing

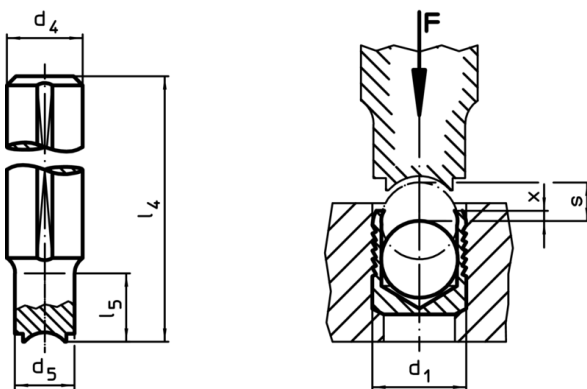

Order information

d ₁	d ₄ h9	d ₅	Dimensions				s	[g]	Art. No.
			l ₄	l ₅	x ±0,2	[mm]			
8	10	7,8	100	20	0,3	3,5	55	22880.0158	

Application example

