

Expander Sealing Plugs· body from case-hardened steel

22880.0006



Product Description

Expander® sealing plugs are used for safe, quick and economic sealing of bore holes in fluid technology, e.g. hydraulic drilling holes in jig and fixture construction. Assembly is effected by pressing in the sealing plug into the drilling hole by means of the prescribed setting die.
Please refer to the technical data following these product information pages.

Material

Body

- Case-hardened steel, zinc-plated, thick-film passivated

Ball

- Roller bearing steel, heat-treated, tempered

More information

Further products

- Setting Dies, for Expander® Sealing Plug

Drawing

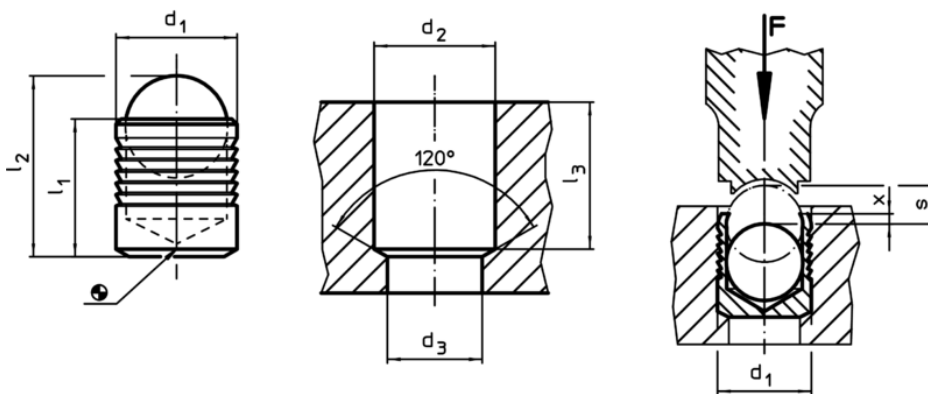

Order information

Dimensions								[g]	Art. No.
d ₁	l ₁	l ₂ ~	d ₂ +0,1	d ₃ max.	l ₃ min.	x ±0,2	s		
6	6,5	8,6	6	5,3	6,3	0,4	2,5	1,3	22880.0006

Application example

Working and control pressures for Expander® sealing plug, sleeve from case hardened steel 1.0403							
basic material	ETG-100 AISI 1144	C15Pb 1.0403	GG-25 DIN 1691	GGG-50 DIN 1693	AlCuMg2 3.1354	AlMgSiPb 3.0615	G-AISI7Mg 3.2371
d ₁ 4-10 mm	p [bar]						
	350	350	350	350	350	320	320
d ₁ 12-22 mm	pTest [bar]						
	1100	1100	1100	1100	1100	1000	1000