

Tolerance Rings

22750.0072

Product Description

The use of tolerance rings (for ball casters with sheet steel housing) allows larger tolerances between the parts to be connected.

Material

- Spring steel strip



Drawing

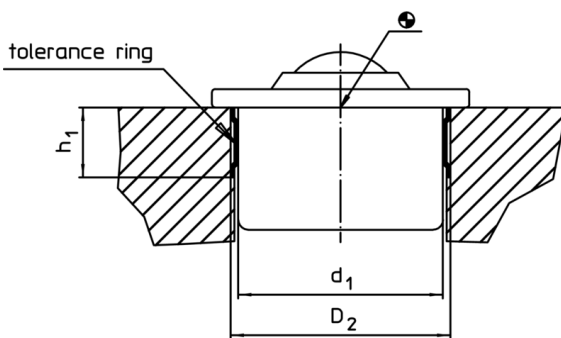

Order information

d ₁	Dimensions		Location hole D ₂ +0,2 [mm]	[g]	Art. No.
		h ₁ +0,2			
45	[mm]	12,1	46,7	5,3	22750.0072

Application example

