

## Tolerance Rings

22750.0064

### Product Description

The use of tolerance rings (for ball casters with sheet steel housing) allows larger tolerances between the parts to be connected.

### Material

- Spring steel strip



### Drawing

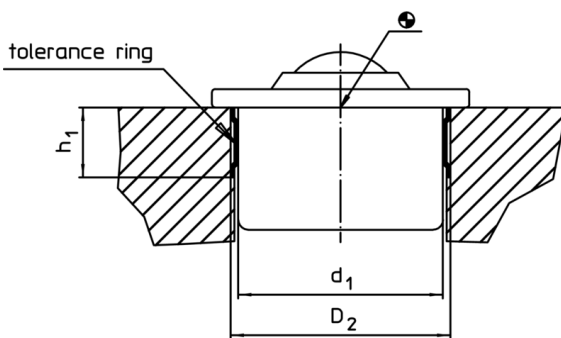

### Order information

d <sub>1</sub>	Dimensions		Location hole D <sub>2</sub> +0,2 [mm]	[g]	Art. No.
		h <sub>1</sub> +0,2			
24	[mm]	7,1	25,7	1,4	22750.0064

### Application example

