

Seating Pins • adjustable

22690.0612



Product Description

The adjustable seating pins can be used as seats and stops.

Material

Seating Pins

- Heat-treated steel, tempered, quality 10.9, blackened / surface induction hardened

Nut

- Heat-treated steel, tempered, quality 8.8 (ISO 4035), blackened

Drawing

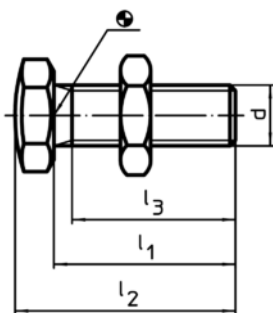

picture 1

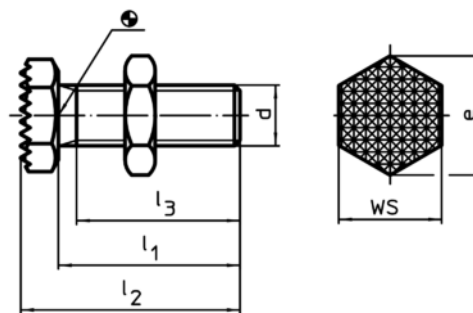

picture 2

Order information

d	l ₁ ±1,5	Dimensions			e	WS [mm]	[g]	Art. No.
		l ₂ ±1,5	l ₃ min.	[mm]				
spherical surface – picture 1								
M12	35	42	29,7	21,9	19	47	22690.0612	

Application example

