

Locating Pins with ball end

22630.0512



Product Description

Ball ended locating pins facilitate easy inserting and removing avoiding clamping inclination.

Material

- Tool steel, hardened, blackened and ground

Drawing

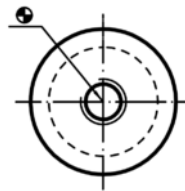
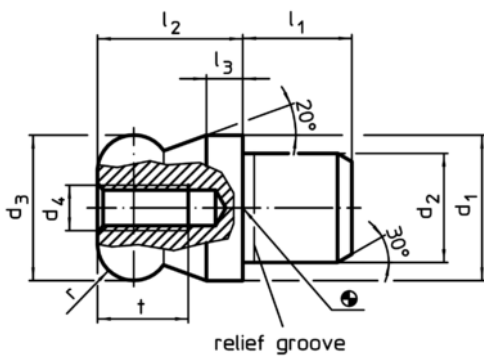

picture 1



picture 2

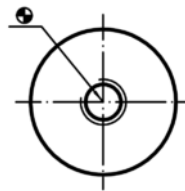
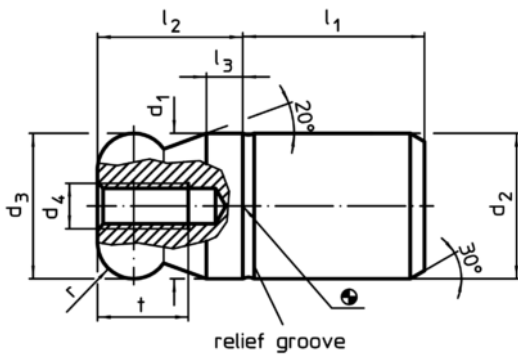

picture 3



picture 4

Order information

Dimensions										Location hole	[g]	Art. No.	
d ₁	d ₂	d ₃	d ₄	l ₁	l ₂	l ₃	t	r	H7				
g6	n6	-0,01 -0,05											
[mm]										[mm]			
with ball end plain, not stepped – picture 3, Tool steel													
12	12	12	M4	15	12	3	8	3	12	21	22630.0512		

Application example

