

Seating Pins • partially DIN 6321 (old norm)

22630.0144



Product Description

To be used as feet and bearings.
Load bearing surface without distortion.

Material

- Tool steel, hardened, ground

Drawing

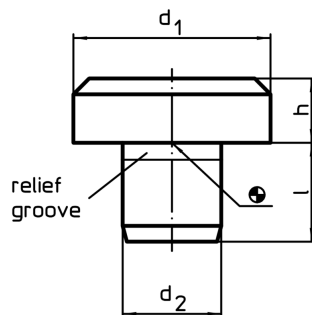

Order information

Dimensions				Location hole	[g]	Art. No.
d ₁	h h9	d ₂ n6	l	H7		
[mm]				[mm]		
intermediate sizes						
30	50	16	20	16	305	22630.0144

Application example

