

Locating and Seating Pins• DIN 6321

22630.0027



Product Description

Cylindric locating pins for locating workpieces in toleranced holes and also to be used as stops and feet.
Flattened locating pin used to overcome differences in tolerances, between holes or to position an element in one direction only.

Material

- Tool steel, hardened, ground

Drawing

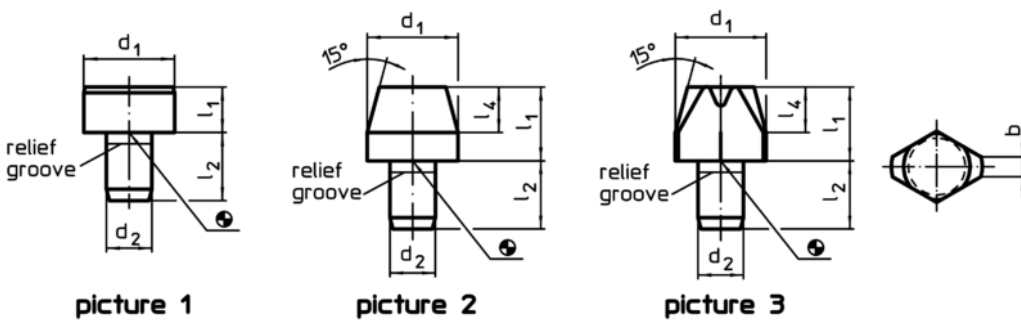

Order information

Dimensions					Location hole	Art. No.
d_1	l_1	d_2	l_2	l_4	H7	
g6		n6				
[mm]					[mm]	[g]
locating pin, cylindric, DIN 6321, form B – picture 2						
12	18	6	9	6	6	17 22630.0027

Application example

