

Seating Pins • partially DIN 6321 (old norm)

22630.0004



Product Description

To be used as feet and bearings.
Load bearing surface without distortion.

Material

- Tool steel, hardened, ground

Drawing

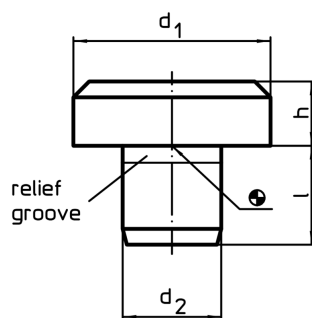

Order information

Dimensions				Location hole	[g]	Art. No.
d_1	h h9	d_2 n6	l	H7		
[mm]				[mm]		
DIN 6321 old norm						
16	13	8	10	8	24	22630.0004

Application example

